



 **MARCEGAGLIA**
BUILDTech

Product datasheet
and instruction for use

MB COPPO MB COPPO MONO





INFORMATIVE NOTE

The technical documentation and suggestions contained in this manual are the best understanding of the company regarding the properties and uses of the products and are intended to support the work of installers and technicians operating in the metal construction sector by providing useful information and suggestions concerning use.

However, given many possibilities of use and the possibility of interference from external elements, the company assumes no responsibility for possible results. It is the responsibility of the user to ascertain the suitability of the product for the intended use, assuming responsibility for any consequential damage.

The user is also required to know procedures necessary for the installation of products, including the preparation of **safety plans** and the updated requirements of all current regulations, in order to avoid dangerous situations.

Values indicated in **the capacity charts** are the result of practical tests carried out in our laboratories and certification bodies; however, the verification of the same, depending on the application, is the responsibility of the design engineer.

For any further information or clarification, please contact the Marcegaglia Buildtech technical office at the addresses listed on the back.

TABLE OF CONTENTS

MB COPPO AND MB COPPO MONO.....	2
Product typology	2
Joint typology.....	3
Technical specifications	4
Metal supports	5
Facings for single sheet panels.....	5
Protection of supports	5
Thermal trasmittance.....	5
Panels weight.....	6
Fire behaviour.....	6
Static characteristics.....	7
Advice and instructions for use.....	8
Thermal expansion	8
Useful design information.....	9
Transport, storage and handling.....	11
Transport and standard composition of packages.....	11
RULES FOR MATERIALS HANDLING, STORAGE AND INSTALLATION	12
Installation instructions	14
Fixing system	14
Installation and equipment.....	15
Installation and fixing of roofing panels.....	16
Examples of solutions for the installation of MB COPPO panels	22
Maintenance and disposal	24
Roof inspection.....	24
Routine maintenance	24
Disposal.....	24
Safety data	25

The dissemination and copying of this document are prohibited - art. 1175 and 2015 of the Italian Civil code.
Any violations will lead to a criminal prosecution as per art. 646 of the Italian Penal code.

MB COPPO AND MB COPPO MONO

MB COPPO - Sandwich panels with polyurethane foam insulation and upper support shaped like the traditional coppo roof tile, used for the construction of sloping roofs.

MB COPPO MONO - Single-sheet panels with polyurethane foam insulation and upper support shaped like the traditional coppo roof tile, used for the construction of sloping roofs.

They have a flexible support on the inside and therefore do not guarantee the same aesthetic qualities as MB COPPO panels.

Imperfections related to flatness, undulations and wrinkles are to be considered a normal product feature.

Product typology

MB COPPO - TCP

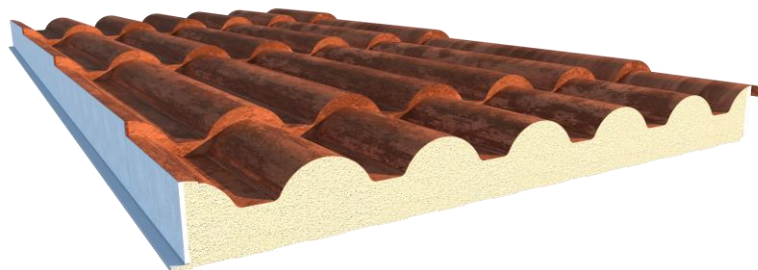
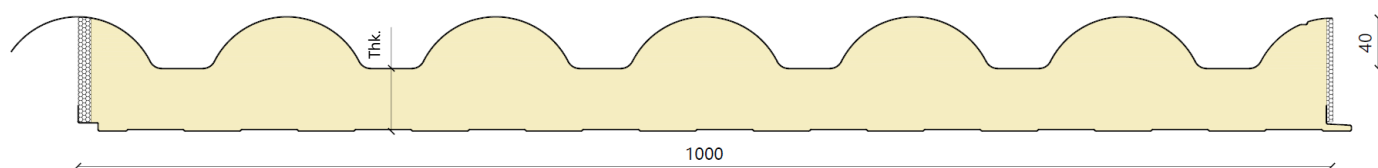

MB COPPO MONO with centesimal alluminium facing - TKC

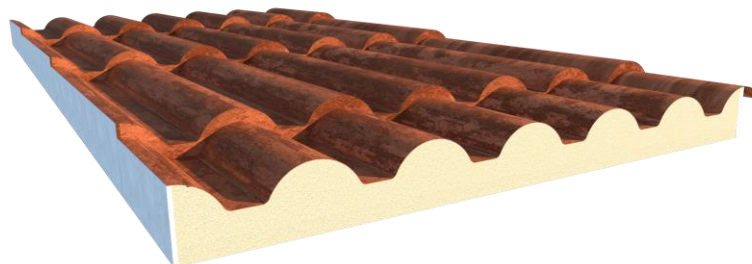
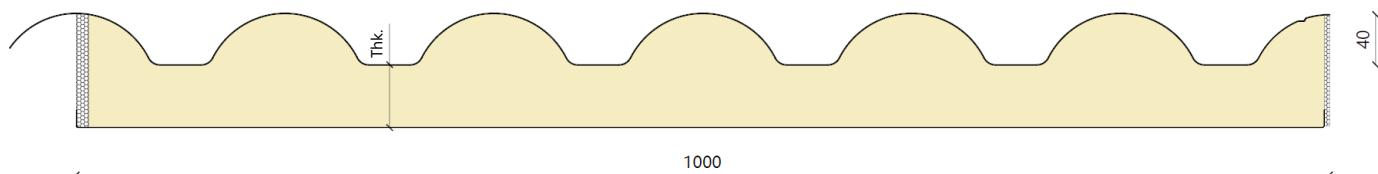

MB OMEGA - TCO

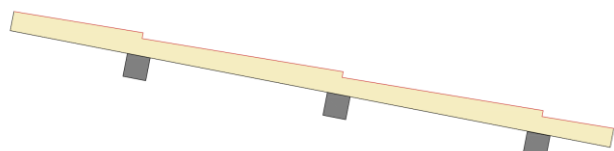
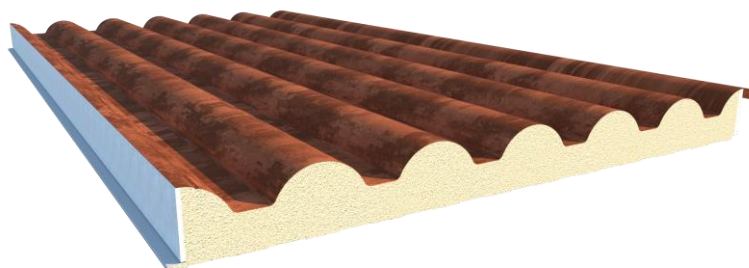
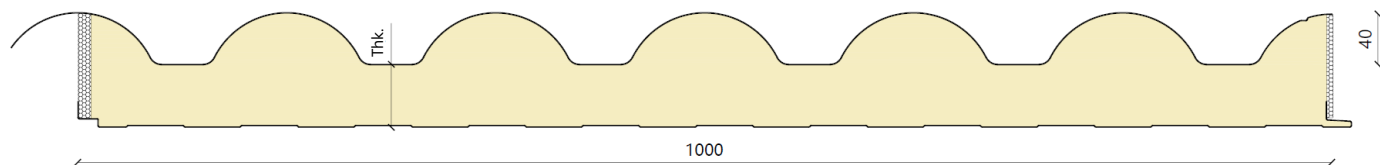

Cross section of the MB COPPO panel that shows the pitch between every "coppo roof tile".

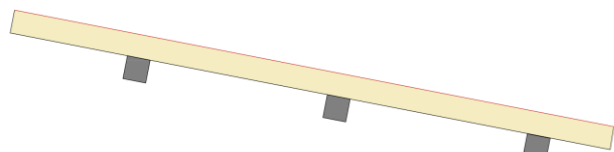

Cross section of the MB OMEGA panel that shows its continuous profile devoid of level differences.

Joint typology

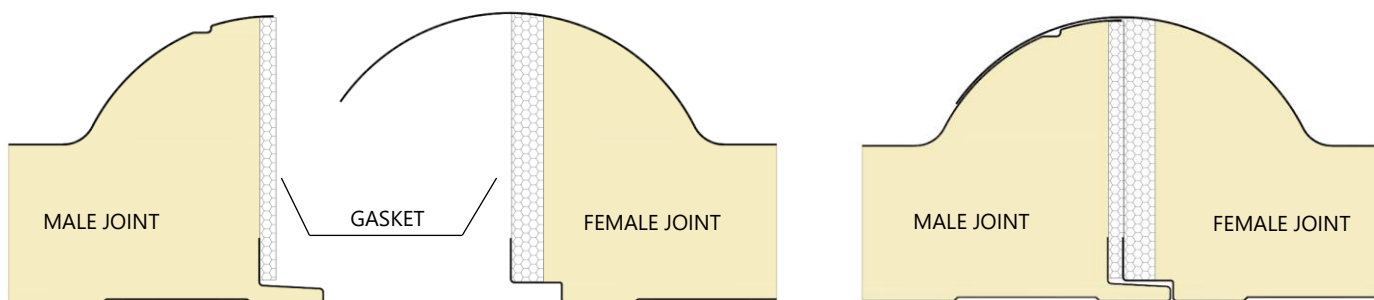

* Several dimensional variables intervene during the production phase for which this gap may be greater than the theoretical value and therefore may not constitute a functional defect of the product or be subject to non-conformity.

GROUT 0÷3 mm*

The male-female joint of the MB COPPO panel designed by Marcegaglia Buildtech requires a fixing system to the metal structure (defined during the design phase) with correctly selected through screws and batz. The gasket inserted during production helps improving the hermeticity of the joint.

Technical specifications

	TKC	TCP	TCO
Useful width	1000 mm		
Length	Variable according to the construction needs related to the dimensions of the roofs to be made. Maximum productive length 15 m. Standard transport limits 13.3 m.		
Panel thickness	40 / 50 / 100		
Insulation	CFC and HCFC-free polyurethane formulations are used which produce anisotropic and anti-mould insulating foams with high content of closed cells (>95%). Particularly high-performance fire reaction foams can be used for fire performance requirements.		
Total average density	38 kg/m ³ ± 10%		
Thermal conductivity λ	λ = 0,022 W/mK		
Slope of the pitch	<p>The slope applied on building roofing must be greater than or equal to 11% (7°). Mild slopes will be permitted only after a technical evaluation of Marcegaglia.</p> <p>An inclination of less than 11% should be avoided to ensure a sufficient rainwater flow to remove debris and dust deposits from the roof. In the presence of protruding parts or transverse joints, it is advisable to increase the slope of the pitch.</p> <p>The correct slope also allows an effective flow of rainwater so as to avoid pooling of water.</p>		
Tolerances <i>From</i> <i>UNI EN 14509</i>	<p>Panel thickness: ± 2 mm if ≤ 100 mm; ± 2 % if > 100 mm</p> <p>Panel length: ± 5 mm if L ≤ 3 m, ± 10 mm if L > 3 m</p> <p>Panel width (pitch): ± 3 mm</p> <p>Coppo (wave) height: ± 2 mm</p> <p>Pitch between coppi (waves): ± 2 mm</p> <p>Deviation from straightness: ≤ 1 mm per meter, ≤ 5 mm</p> <p>Deviation from flatness: ≤ 1,5 mm per L > 700 mm</p> <p>Deviation from squareness: ≤ 0,60% of panel nominal width</p>		
	Slight spills of foam coming out from joints and any minor faults or irregularities in the position of gaskets are considered normal.		

Metal supports

Marcegaglia Buildtech offers the following metal support variants in the panels configuration:

Pre-painted steel, according to EN 10169 (coil coating) according to EURONORMS:

- of standard production:
 - with MP3 polyester coating
- of special production:
 - with modified MP5 polyester coating
 - with MP10 polyvinylidene coating
 - with MP20 polyurethane / polyamide coating

Plasticized galvanized steel EN 10346

Natural aluminium, pre-painted EN 485-2, EN 573-3, EN 11396.

Facings for single sheet panels

Marcegaglia Buildtech offers the following facing variants in the panels configuration:

- **Aluminium foil**
- **Bituminous felt paper**

Protection of supports

To prevent pre-painted metal supports from being damaged during the production and subsequent movement of panels, a polyethylene adhesive film is used which must be removed during the installation phase or in any case not later than 30 days from the production of panels.

Please note that it is highly recommended not to store panels in a place with prolonged sun exposure.

Marcegaglia Buildtech strongly advises against the request for material without a polyethylene adhesive film and assumes no responsibility for any damage in the event that such a request is submitted.

Thermal trasmittance

Independently from the family of products, the value of U reported here is calculated accordingly to UNI EN 14509.

Panel thk. [mm]	Thermal trasmittance [W/m ² K]		
	40	50	100
U (EN 14509)	0,53	0,42	0,21

Panels weight

MB COPPO - TCP

STEEL

Supports thk. [mm]	Weight per panel thickness [Kg / m ²]		
	40	50	100
0,50 / 0,40	9,45	9,85	11,75
0,50 / 0,50	10,30	10,70	12,60

ALUMINIUM AND STEEL

Supports thk. [mm]	Weight per panel thickness [Kg / m ²]		
	40	50	100
0,70 / ,050	7,90	8,25	10,15

MB COPPO MONO - TKC

	Supports thickness [mm]	Weight per panel thickness [Kg / m ²]		
		40	50	100
Steel	0,50	6,60	6,95	8,85
Aluminium	0,70	4,15	4,55	6,45

The indicated average weight can increase or decrease up to a maximum of 5%

Fire behaviour

Fire behaviour from the outside (Broof)

This refers to the capacity of a building roof to prevent an external fire from entering the building and is based on tests that simulate the ignition and propagation of the fire on the roof:

- **t1**, burning ember only;
- **t2**, burning ember in the presence of wind;
- **t3**, burning ember in the presence of wind and irradiation;
- **t4**, burning ember in the presence of wind and additional radiant heat.

MB ROOF panels can reach different Broof performance levels under certain configuration conditions agreed upon with the technical and commercial office. The declaration concerning the performance degree will only be issued under these conditions.

Please note that the mechanical, reaction and resistance performance to fire and behaviour to fire on roofs must be requested and agreed upon in advance when purchasing the material.

Unless specifically requested, the product supplied will have no fire behaviour performance.

Static characteristics

Capacity values in the charts below refer to panels subject to a distributed load, but they do not take into account thermal effects that must be considered by the designer. Concerned data are therefore indicative and cannot replace design calculations drawn-up by an expert and qualified technician who must verify and validate these indications taking into account the regulations in force at the place of installation. The number and layout of fastening systems must be defined by the designer.

The mechanical performance shown in the table has to be considered valid only under **positive pressure** wind action conditions, with a minimum useful width of the supports of 120 mm, so the action of depression/suction loads should be evaluated case-by-case.

For further details and information, please contact the Marcegaglia Buildtech Technical Office.

MB COPPO - TCP

MB COPPO PANEL STEEL+STEEL								
Panel thickness	Supports thickness	Uniformly distributed positive load in kN/m ² [1/200 span]						
		MULTIPLE SPAN [m]						
mm	mm	1,05	1,40	1,75	2,10	2,45	2,80	3,15
40	0,50/0,50	3,80	2,60	1,90	1,50	1,20	0,95	0,75
	0,50/0,40	3,61	2,47	1,81	1,43	1,14	0,90	0,71
50	0,50/0,50	6,10	4,20	3,10	2,40	1,90	1,50	1,20
	0,50/0,40	5,80	3,99	2,95	2,28	1,81	1,43	1,14
100	0,50/0,50	8,91	6,13	4,53	3,50	2,77	2,19	1,75
	0,50/0,40	8,46	5,83	4,30	3,33	2,64	2,08	1,66

MB COPPO PANEL ALUMINIUM+STEEL								
Panel thickness	Supports thickness	Uniformly distributed positive load in kN/m ² [1/200 span]						
		MULTIPLE SPAN [m]						
mm	mm	1,05	1,40	1,75	2,10	2,45	2,80	3,15
40	0,70/0,50	2,71	1,80	1,30	1,00	0,80	0,60	0,50
50	0,70/0,50	4,35	2,90	2,10	1,60	1,28	0,95	0,80
100	0,70/0,50	6,35	4,23	3,07	2,34	1,87	1,39	1,17

MB COPPO MONO - TKC

MB COPPO MONO panels must be installed on a continuous slab or on 350 mm span purlins as shown in the picture below.

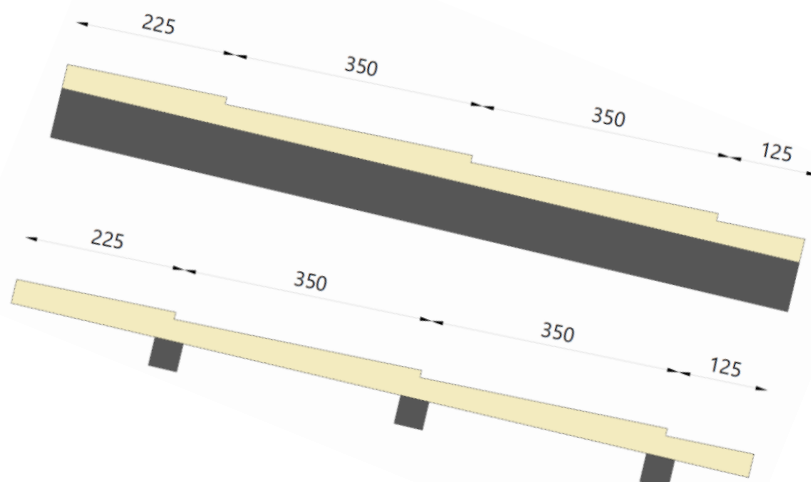

Advice and instructions for use

Thermal expansion

Sandwich panels, given the nature of materials they are made of, are subject to the natural phenomenon of thermal expansion in the presence of a thermal excursion acting on metal supports.

This phenomenon acts on the straightness of the panel causing bends and deformations that can affect the functionality and the aesthetic appearance in the event that proper precautions are not taken.

The following conditions may affect the deformation of panels:

- Significant lengths (e.g. ≥ 5 m)
- High solar radiation
- Dark supports colour ($R_G = 8-39$, EN 14509:2013)
- Supports material
- Support thickness
- Polyurethane foam insulation core, specifically polyisocyanurate foam

The following charts illustrate the linear thermal expansion coefficients of different metals used for supports.

Material	Linear thermal expansion coefficient [°C ⁻¹]
Steel	$12,0 \times 10^{-6}$
Stainless steel AISI 304	$17,0 \times 10^{-6}$
Aluminium	$23,6 \times 10^{-6}$
Fiberglass	$3,2 \times 10^{-5}$

Colour	Surface temperature [°C]	
	Minimum	Maximum
Very light ($R_G = 75-90$)	-20	+55
Light ($R_G = 40-74$)	-20	+65
Dark ($R_G = 8-39$)	-20	+80

The system must absorb linear elongations of the support due to high surface temperatures.

In the event of thermal fluctuations that are repeated in short periods such as day-night or freeze-thaw fluctuations, tensions are generated on supports that can cause undulations, imperfections and in some cases even wrinkling phenomena.

Marcegaglia Buildtech recommends:

- Taking into account deformations due to the thermal expansion of materials during the design and selection of panels.
- Segmenting panels
- Avoiding dark colours, especially with significant lengths.
- Choosing the thickness of metal faces in a manner appropriate to the use and calculated deformations.
- Determining adequate fastening systems to compensate for expansions.

Useful design information

Marcegaglia Buildtech points out that it is necessary to dimension a load-bearing structure in the design phase that can absorb external load stresses so as not to jeopardize the basic functionality of panels due to excessive and permanent deformations.

The following environmental conditions must be taken into consideration during the design and selection of panels:

- **Thermal stress:** can lead to significant deformation of panels and depends mainly on the exposure of the building and on the colour of the external metal support.
- **Wind action:** exerts a loading pressure on exposed surfaces of the panel according to the wind speed, which varies according to the climatic zone in which the installation takes place. It is necessary to define the type and number of fixings according to the intensity of the described action.
- **Atmospheric aggressiveness:** it is necessary to choose the covering of supports suitable for the environment in which panels are installed (marine, industrial, urban, rural), since some environments are particularly aggressive in terms of corrosiveness of panel surfaces.
- **Snow load:** varies according to the climatic zone and the altitude above sea level of the place where the installation takes place. It is necessary to take into account the possible pooling of water on the roof when snow is melting, which can lead to infiltration at the overlapping joints. Marcegaglia Buildtech recommends the adoption of appropriate constructive measures and suitable sheet metalwork systems to optimize the runoff of water.
- **Rainfall:** the slope of the pitch must be defined taking into account the amount of rainfall at the place of installation. To avoid oxidation of metal supports due to incorrect water runoff, it is necessary to define the slope of the pitch depending on the type of construction used:
 - roofing without intermediate butt joints;
 - roofing with intermediate butt joints.

If intermediate butt joints are not used, Marcegaglia Buildtech recommends implementing a slope of not less than 11% in situations of reduced or medium snowfall; if intermediate butt joints are used, it is necessary to define the slope of the pitch during the design phase, providing for an increase compared to the previous situation due to the presence of overlaps.

To prevent infiltration into the insulation or inside the building and a possible consequent premature deterioration of the panel head, Marcegaglia Buildtech recommends creating a drip, requesting in advance the predisposition for the eave protrusion. Also note that the continued exposure of panel heads to stagnant water can cause the onset of oxidation of the metal or the detachment of the insulating material.

Even if the use of the drip is preferable, it is possible to consider as an alternative solution a protection of the head in the form of a liquid membrane.



Note that the nature of metallic coatings in conditions of solar radiation permits the external surface temperature of the panel to reach very high temperatures ($80 \div 90^\circ \text{C}$), with consequent possible bending and wrinkling of the sheet. Marcegaglia Buildtech, in order to limit the occurrence of such phenomena, recommends a choice of colours, lengths and thicknesses of metal supports that takes into account the conditions of the installation environment, preferably with light colours, limited lengths and supports with minimum thickness 0.60 mm.

If the possibility of using panels with an internal support different from the external one is taken into consideration, it is necessary to take into account possible deformations due to different coefficients of thermal expansion.

In particular environmental conditions, it is possible for condensation to form on internal surfaces of panels with consequent dripping inside the building; this phenomenon, if not addressed in a sufficiently short time, can promote the natural deterioration of the paintwork and supports.

Therefore, Marcegaglia Buildtech recommends taking the described phenomenon into consideration during the design phase and possibly performing a thermo-hygrometric check in order to choose the best solution.

Marcegaglia Buildtech also recommends stocking spare panels beforehand (about 5% of the total), so as to make up for any lack of material due to damage during handling and installation.

IMPORTANT

When the product configuration varies, the technical characteristics and method of use may change. Therefore, Marcegaglia Buildtech recommends checking the suitability of the configuration and possible contraindications with the sales and technical departments.



Transport, storage and handling

Transport and standard composition of packages

Panels are supplied in a horizontal position, in storage packages that allow handling both by lifting straps and by fork lift trucks.

The standard number of panels contained within the single package varies according to the size and thickness of the panel (see chart).

Before proceeding with unloading and handling operations, it is advisable to check the weight of each package (variable according to panel lengths) and choose a lifting means of adequate lifting capacity.

The handling of loads and materials on site must always take place in compliance with the requirements of the safety regulations in force with the use of the appropriate personal protective equipment provided by the said regulations.

Thickness	Panels / packaging	Packaging height (including blocks)
mm		mm
40	10	766
50	8	710
100	4	598



RULES FOR MATERIALS HANDLING, STORAGE AND INSTALLATION

During the handling, storage and installation of materials, precautions must be taken to ensure the following:

- **protection of the surface from abrasion**, especially during handling;
- **protection against water stagnation or condensed moisture** that could lead to blistering;
- **protection** of the elements supporting the mass of the entire parcels, or of stacked parcels, **against permanent deformation**.

The best storage conditions for parcels are **indoors, with light ventilation, free of moisture and not dusty**. In any case, it is necessary to provide a suitable stable support surface that does not allow water to stagnate (**slight slope, minimum 5%**).

If storage is not followed shortly by removal for installation, it is a good idea to cover the parcels with protective tarpaulins suitable both for impermeability and internal ventilation.

Generally, parcels should not be stacked; if it is considered possible to do this, a **maximum of three parcels** may be **stacked**.

Parcels must not be placed in areas close to work (e.g. metal cutting, sandblasting, painting, welding, etc.) or in areas where transit or parking of operating vehicles may cause damage (impacts, splashes, exhaust gases, etc.).

If the materials are **covered with protective film**, this must be completely removed during assembly, but **preferably within 15 days and no later than 30 days from the date of "notice of ready goods"** and provided that the parcels are stored in a shady, covered, ventilated place protected from all types of weather. If materials are ordered, produced and delivered **without a protective film** on the painted substrate, **great care** must be **taken not to cause damage during handling and assembly**.

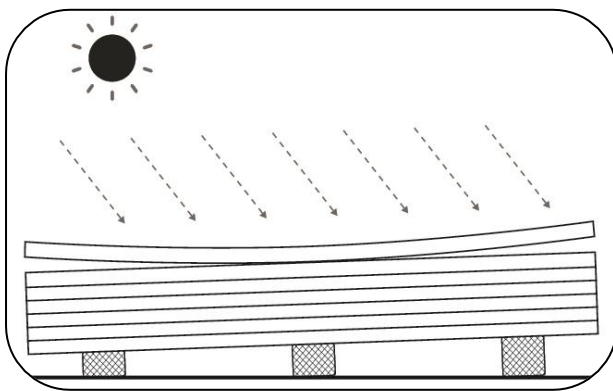
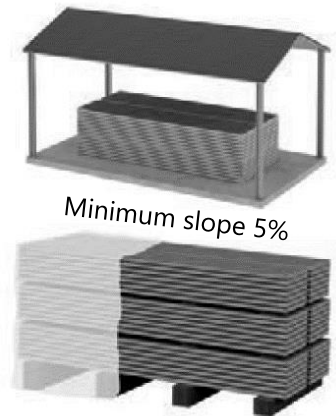

In order to maintain the original performance of the product, it is advisable, in accordance with these standards, **not to exceed six months** of continuous **storage in a closed and ventilated environment**, while storage in the **open air should never exceed two weeks**. The materials must **always be protected from direct sunlight**, as this can cause deterioration. During assembly, panels subjected to sunlight suffer a bowing that makes assembly difficult, so it is recommended to shade the parcel in use.



In the case of **transport in a container**, the products must be **removed from the container within 15 days from the date of shipment** in order to avoid deterioration of the pre-painted metal substrates due to the high concentration of moisture that can accumulate in the closed container for so long.

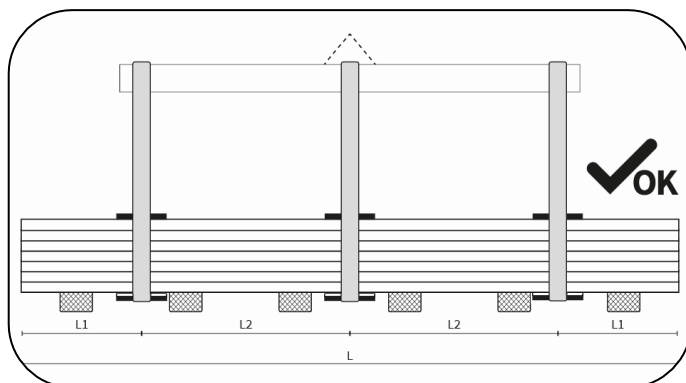

In handling, parcels must always be slinged at least two points not less than half the length of the parcels.

Lifting should preferably be carried out with **synthetic fibre (nylon) woven straps** with a width of no less than 10 cm so that the load on the strap is distributed and does not cause deformation.

Special **spacers** must be used below and above the parcel, consisting of sturdy flat elements of wood or rigid plastic material protected by softer material to prevent direct contact of the belts and damage to the panel in the parcel.

Gripping of parcels in the wrong manner such as using incorrect and/or incorrectly dimensioned gripping equipment or without considering the correct distance of the gripping points can lead to alterations and consequent damage to the panels in the parcel.

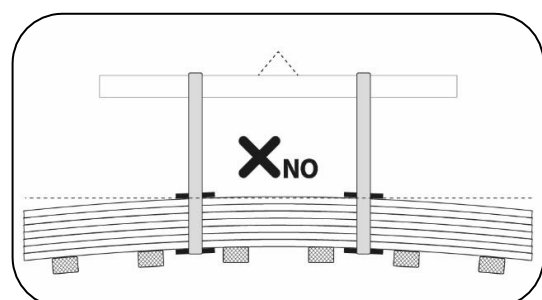
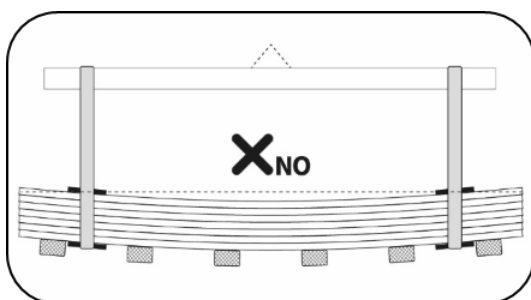

In the absence of a sling bar, in some cases unloading can also take place using suitable **forklift trucks**.

In order to avoid damage to the panel or even breakage of the parcel, the lifting equipment must have fork spacing and fork width **that take into account the parcel length, weight, and thickness of the panels** that affect the bending of the parcel.

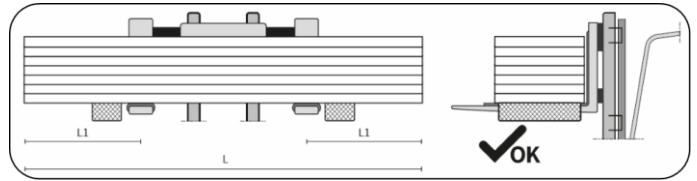

If the parcel is lifted in an unbalanced manner, not taking into account the correct gripping points, there is a risk of consequences such as the parcel falling or the panels being deformed and damaged.

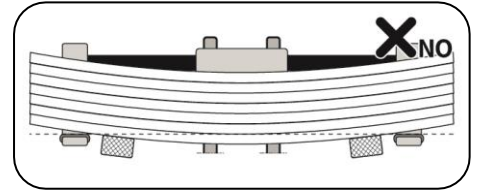
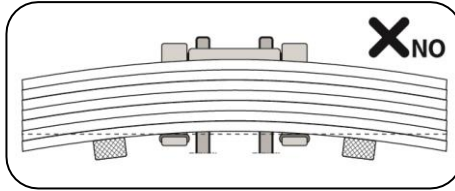
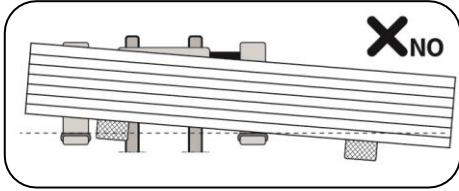

Handling of panels on site must be carried out with suitable **lifting systems** that have been **adequately designed and dimensioned** so as not to cause damage to the material during assembly.

Manual handling of the individual element must always be carried out by lifting the element itself **without sliding** it over the lower element and, if necessary, by rotating it by the side of the parcel, taking care not to damage the longitudinal joint of the panel; transport, if by hand, must be carried out by at least two persons depending on the length.

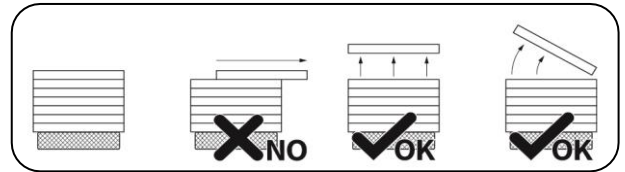

If necessary, depending on the size and weight of the individual panel, it is advisable to provide suitable mechanical lifting devices, such as **suction cup lifters** or special **grippers/jaw clamps**.

If suction cup systems are used, **an adequate distribution and number of suction cups** in relation to the surface area and weight of the panel must be provided; the system must be equipped with suction cups suitable for lifting sandwich panels, e.g. that can support the possibility of inserting **special pads** inside the suction cups to **prevent the metal support from detaching**. When present, the protective film on the metal support must be removed prior to the application of the suction pads, at least in the affected portion.

The study and analysis of the suction cup systems to be used is essential to avoid damaging the panels, so it is advisable to design suitable solutions by also discussing with the suppliers of the systems as experts in the field. **Failure to design the lifting system can lead to panel breakage as a result of panel imbalance.**

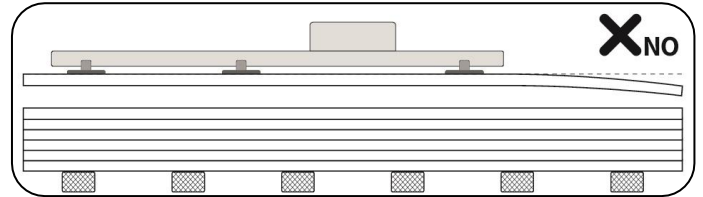
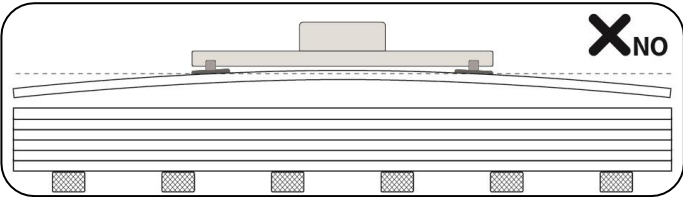
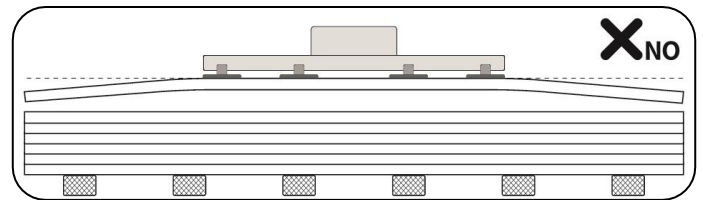
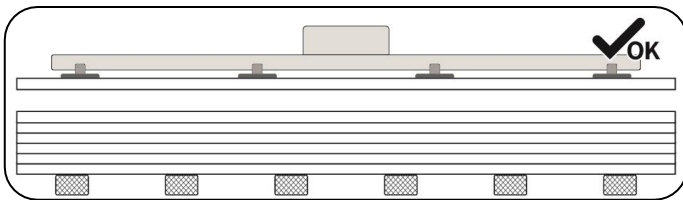

The following are, by way of example, two conceptual solutions for correct suction cup systems in which the suction cups are properly distributed according to the length of the panel.

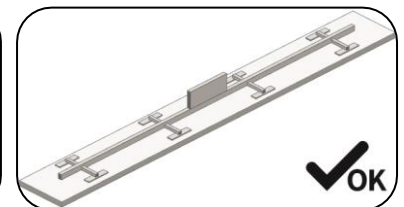
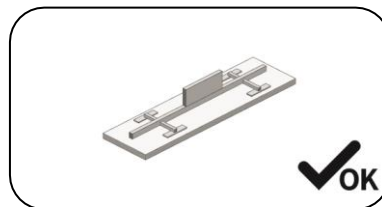

The panels must be installed by qualified personnel who are familiar with the rules of good engineering.

Instructions for use can be found in the product manuals that can be downloaded from our website www.marcegagliabuildtech.it under "catalogues and manuals". Personnel equipment, in particular all PPE, must be such as to ensure the safety of the worker and prevent damage to the panels during handling and installation.

WARRANTY Failure to comply with these minimum requirements shall exempt Marcegaglia Buildtech from any liability for damage to the products and the forfeiture of the warranty provided for in the terms and

Installation instructions

Fixing system

The most appropriate fixing system for the project must be established according to the type of installation, considering support structures (metal structural work) in order to guarantee safety, stability and leak-tightness.

Fixing elements must be able to withstand dynamic forces of stresses to which insulated panels are subjected (sudden changes in temperature, wind load, trampling, etc.) guaranteeing the mechanical sealing, load capacity and insulation.

The number and positioning of fixings varies according to the design and according to several variables, including local wind conditions, the distance between the purlins and framework elements, and the height of the building.

The **support system** consists mainly of purlins: usually wooden, concrete or steel purlins are used (thickness ≥ 2 mm), more rarely aluminium (thickness ≥ 3 mm).

The minimum surface of the end supports or intermediate supports depends on characteristics of the panel and the material of supports, therefore it is advisable to rely on the calculation section of the support reaction resistance of the UNI EN 14509 standard.

There are two types of fixing:

- **Main structural anchors**

These fix the roof panel to the supporting structure and guarantee the anchoring, the mechanical resistance and the load capacity applied. The standard fixing group includes: self-tapping / self-drilling screw and batz. The choice of the screw length will depend on the thickness of the panel and the type of underlying structure. The fixing is made in correspondence of the top point of the wave shape: to have a better anchorage a **batz** is inserted between the screw and the profiled sheet, which adapts to the curve profile of the sheet.

- **Stitching**

Non-structural, they are functional for fixing the sheet metal, metal finishing elements and sheets of the panel to each other.

The fixing equipment is divided into:

- **Self-tapping screws (A)**

These are applied after having prepared the hole in the panel and on the roof purlin.

- **Self-drilling screws (B)**

These are applied directly without the preparation of holes using a screwdriver only.

-

- **Wood screws (C)**

- **Stitching screws (D)**

Smaller in size, they are used for the fastening of sheet metal elements and for stitching the overlap.

- **Batz (E)**

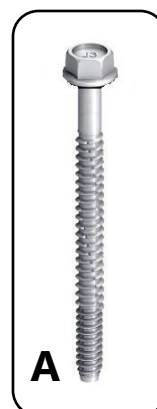

Installation and equipment

Supporting structures and relative fixing devices of panels must be adequately sized and must meet the conditions set by the project in terms of safety, stability and functionality. This section aims to provide reference information for the assembly of insulated metal roofing panels. The reference standard is constituted by the **UNI 10372 standard "Discontinuously laid roof coverings - criteria for design, execution and maintenance of roofing made of metal sheets"**.

Preliminary operations:

- View project documents and follow relevant instructions.
- Check that the support structure is positioned correctly, does not present deformations or misalignments and is completely secured to the rest of the structure.
- Make sure that there is no interference with overhead power lines in the handling area of materials.
- Prepare appropriate accident prevention facilities according to the regulations in force for work at height.
- Check that all workers operating at height are equipped with appropriate personal accident prevention devices according to the regulations in force.
- Prepare power supply lines for the equipment used according to current regulations.
- Remove the protective film applied to pre-painted sheets over the entire length of the panel.

Hoisting: panels must be lifted with the utmost care and attention, avoiding to damage the surface. In most cases it is necessary to move packs of panels onto the roof to be covered (hoisting). the use of steel cables or chains instead of nylon slings must be strictly avoided.

Hoisted panels must be placed on purlins (never on overhangs) near trusses, avoiding laying more than one row of packs for each truss. Suitable stopping systems must also be set in place to prevent packs from slipping due to the slope of the roof or due to the wind at high altitude, paying more attention once the package is opened. It is important to ensure that, at the end of the working day, open packs on the roof that are not yet finished are temporarily strapped so as to prevent them from sliding down or flying away under the action of the wind.

Installation equipment

The use of suitable tools and equipment in an suitable state of maintenance are required for the installation of insulated panels. The following list shows, in a non-exhaustive manner, the equipment which is recommended for use and those the use of which must be strictly avoided.



Lifting with suction cups

If the suction cup lifting system is taken into consideration, the surface area of the suction cups must be appropriately dimensioned and the correct number of gripping points must be defined according to the length, thickness and weight of the panels. An improperly designed suction cup system can lead to deformation of the panel and detachment of the sheet from the insulation layer.

Installation and fixing of roofing panels

Once all preliminary activities have been carried out, based on project drawings, it is necessary to **prepare and install the complementary sheet metalwork** to complete the roofing, for example, under-ridges, gutter channels, flashings and anything under the panel.

Once profiles have been laid, the starting point for the installation of the first panel must be carefully identified.

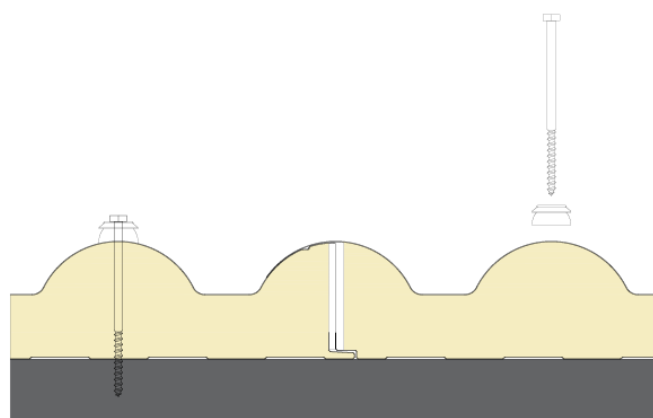
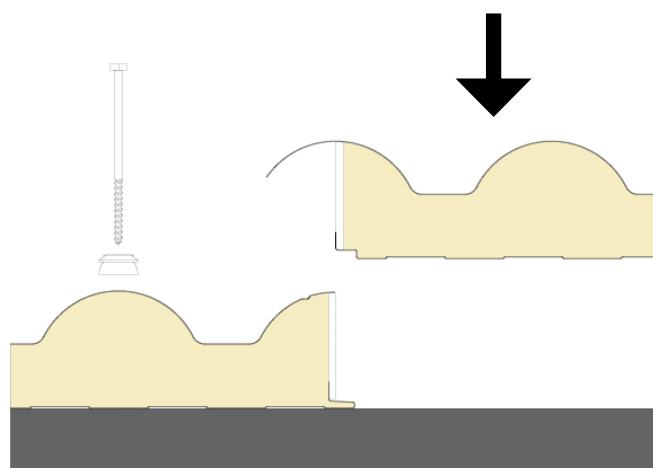
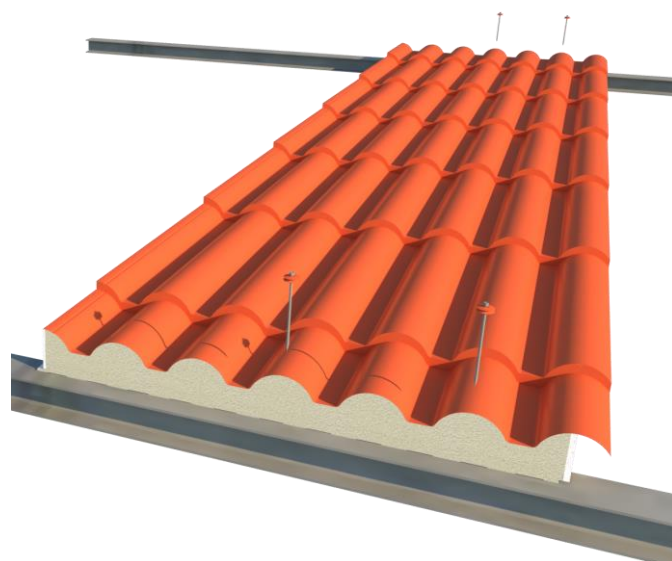

Fixing of panels with the batz interposed between the appropriate screw and the panel.

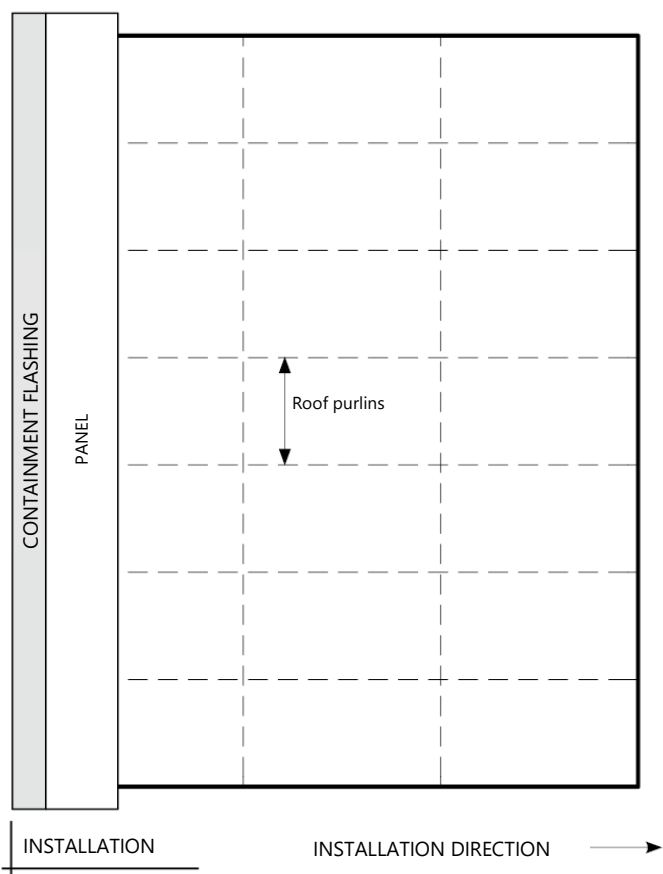

Once the starting point is set and alignments have been checked with respect to the structural work, it is possible to start laying the first roofing panel, **following the intended installation direction**.

Position and then anchor the first panel, always making sure to check its alignment with the underlying purlins.

For the first panel only, fix it on the top part of the first full wave (coppo) available, for each underlying purlin.

Overlap the half-empty wave (coppo) of the second panel on the half wave of the first keeping an offset as shown in the picture below.

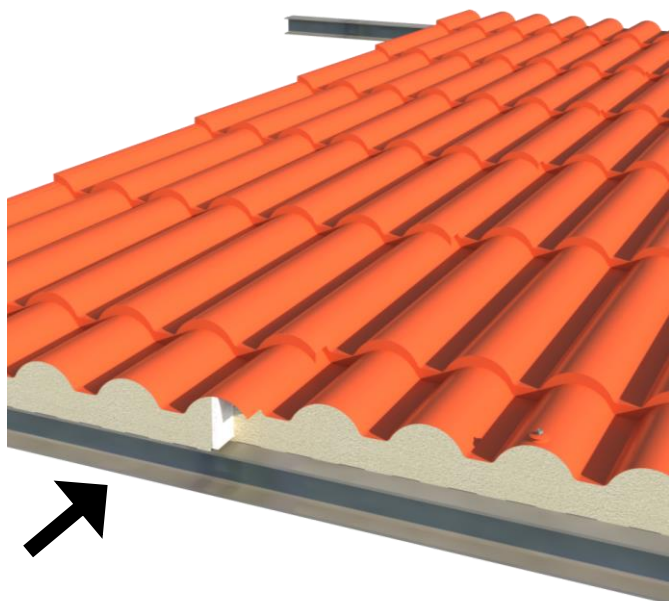
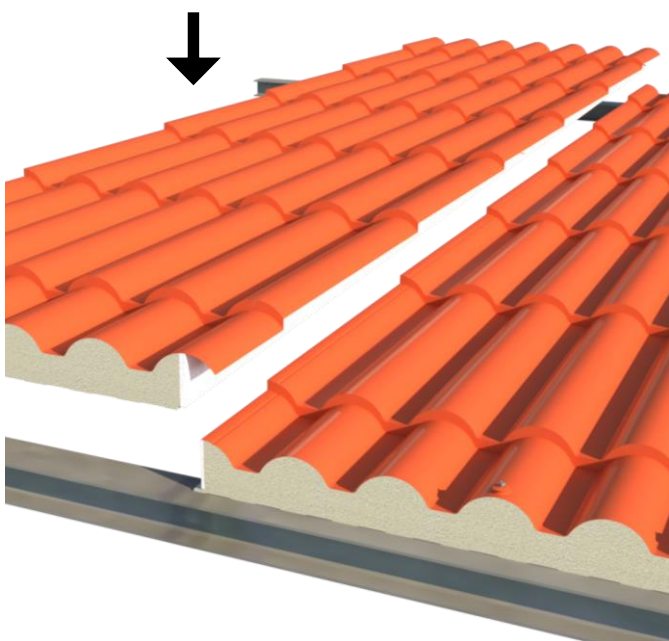

As the panel is placed, it is appropriate to push it and align it with the fixed panel in order to obtain a good coupling between waves (coppi) in correspondence of waves height gap.

Once the panel has been positioned, it is advisable to apply lateral force to ensure that panels are well secured.

Slight differences in the longitudinal dimension of the panels are to be considered tolerable.

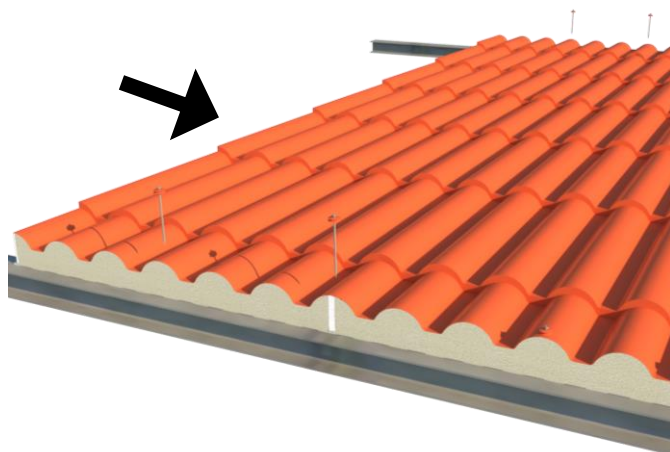

Maintaining the pressure exerted, place the first fixing screw on one of the free wave (coppo) after the joint, making sure that it is perpendicular to the surface of the panel.

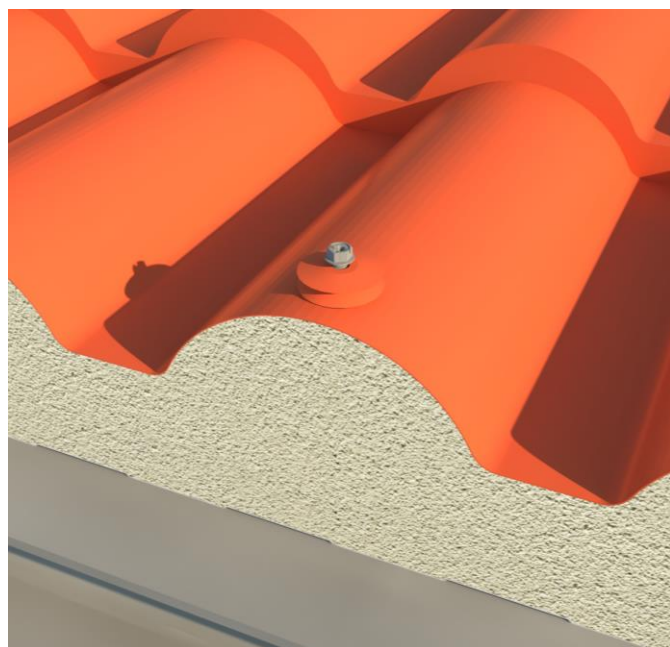

Finally, check for perfect overlapping, making sure that external surfaces of the two adjacent panels are completely in contact and levelled.

Similarly, proceed with the installation of subsequent panels according to installation sequences provided in the design phase.

When carrying out installation operations, avoid placing pointed or sharp objects and concentrated loads on panels surfaces. Also avoid performing other welding or cutting operations in the immediate vicinity of panels.

With regard to the fixing methods, some valid indications are provided below:

- **Ridge and eave end supports (A):**
application of minimum five screws per panel.

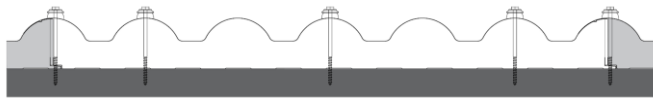

- **Internal supports (B):**
application of at least three screws per panel.

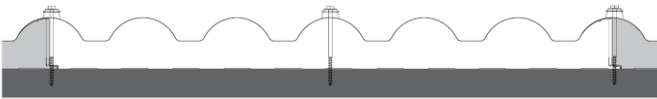

- **Supports with transversal overlapping (C):**
application of minimum five screws per panel..

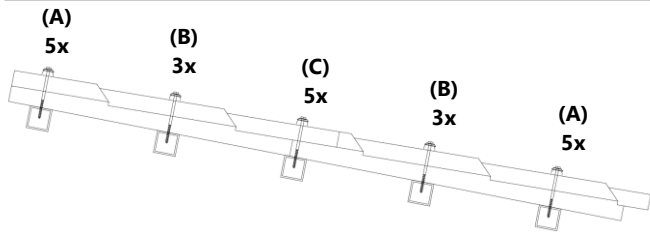
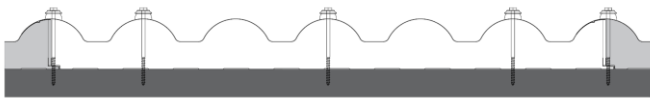

Fix the roofing panel with appropriate screws.

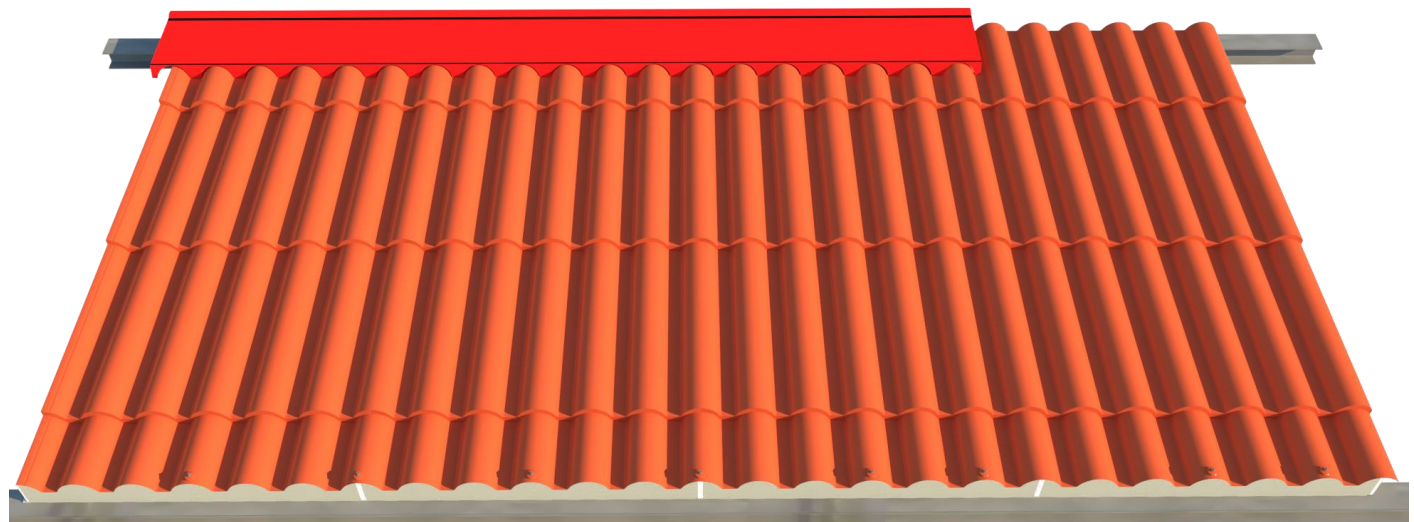

3000 mm ± 6 mm



Pay close attention to the right coupling of panels during the installation (3 panels = 3000 mm ± 6 mm) in order to avoid problems during the installation of the roof ridge. The picture above shows that the roof ridge is a metal sheet bending product with a fixed pitch. The right coupling of panels is strictly needed to avoid matching difficulties between the roof ridge and waves. Overlapping

The chart shows **recommended screws useful lengths** according to the roofing panel thickness in mm.

For purlins or wooden or concrete supports, add 10 mm to indicated lengths.

Panel thickness	Minimum screws lenght
40	100 mm
50	110 mm
100	160 mm

For each type of project, depending on wind conditions, the topography of the land and the length of purlins, it will be up to the designer to identify the number of fixings to be applied (their function is also that of reacting to negative loads).

On completion of any cutting, drilling and fixing operation, make sure that **any metal scraps are thoroughly removed** to ensure that surfaces remain clean.

When the length of the pitch requires the use of several panels in a longitudinal direction of the panel itself, it is advisable to install panels starting from the eaves line and continuing, once the first course of panels is completed, towards the ridge line.

It is possible to choose between two different overlapping systems, but independently from the system chosen, in order to give to the overlapping a greater resistance to atmospheric agents, it is good practice to place one or two strips of sealing material between sheets downstream of the fixing unit.

It is also a good idea to apply self-expanding gaskets on the purlin on which overlapping takes place, to avoid thermal dispersion.

The overlapping between panels is executed as illustrated in the following images.

Simple overlapping

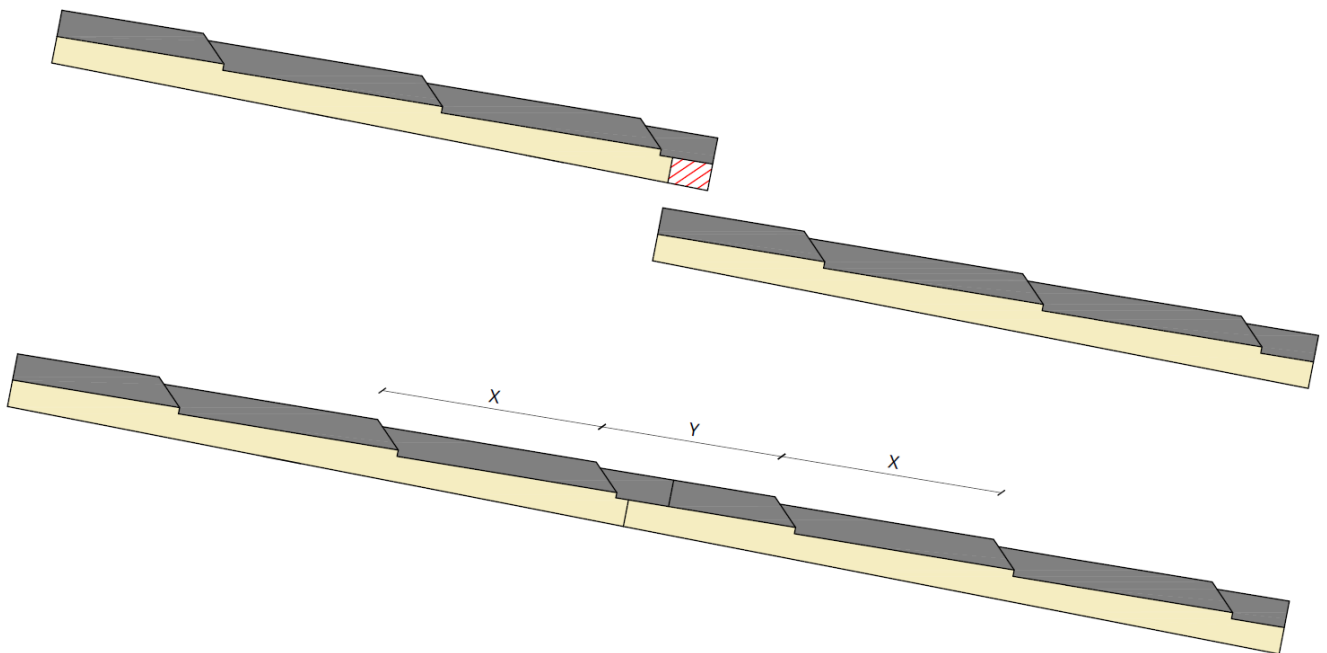

This overlapping method consists in the removal of a limited portion of the polyurethane foam in correspondence of the head side of the upstream panel that will overlap on the downstream one.

The simple overlapping system allows to avoid the removal of polyurethane foam from the waves height gap (coppi) but it is NOT possible to have a regular seized wave (350 mm) in correspondence of the overlapping.

The upstream sheet portion that overlaps on the downstream one is small and it is necessary a feasibility study of the system, case by case, but the simple overlapping is the most economic and easy-feasible solution.

Advanced overlapping

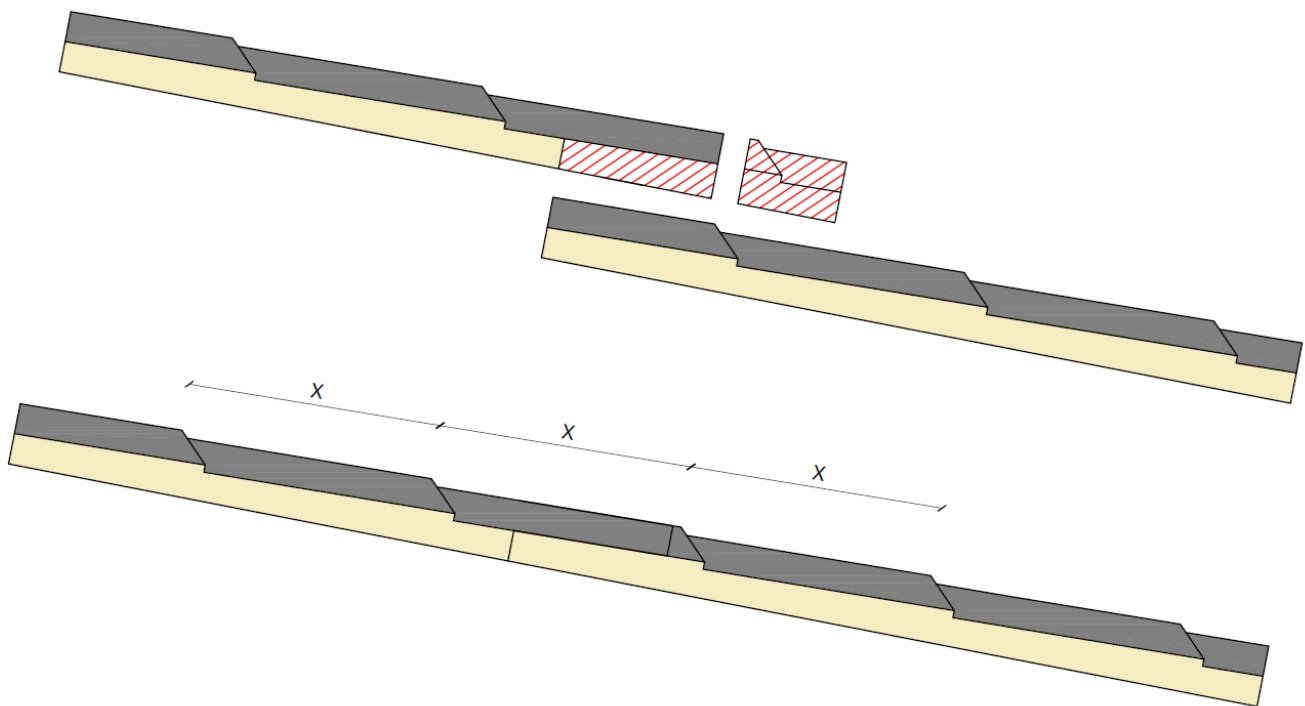

This overlapping method consists in the cut of a portion of the panel and the further removal of the polyurethane foam in correspondence of the head side of the upstream panel that will overlap on the downstream one.

The advanced overlapping system allows to have a regular 350 mm pitch of waves (coppi) in correspondence of the overlapping and even if it is the best technical option it requires a large number of post-production machinings which significantly increase its cost.

Fixing the panels

Once the panel is in place, make the first hole with the drill. Always make sure the hole is perpendicular to the panel surface.

To properly fix the two overlapping panels in the joint area, it is recommended to use an **additional fixing**, as described in the following image.



In this way shear stresses are more effectively discharged on the supporting structure, through fixing units. This layout is suitable above all for overlapping panels of great length.

The sheet of the upstream overlapping panel is overlapped on the downstream one and is fixed with stitching screws in correspondence of waves, so as to avoid deformation and bending of the overlapping sheet.

To ensure a uniform effect on roof panels, they should be connected where they overlap between one purlin and the other, with a 6.3x20 mm diameter stitching screw, with a batz.

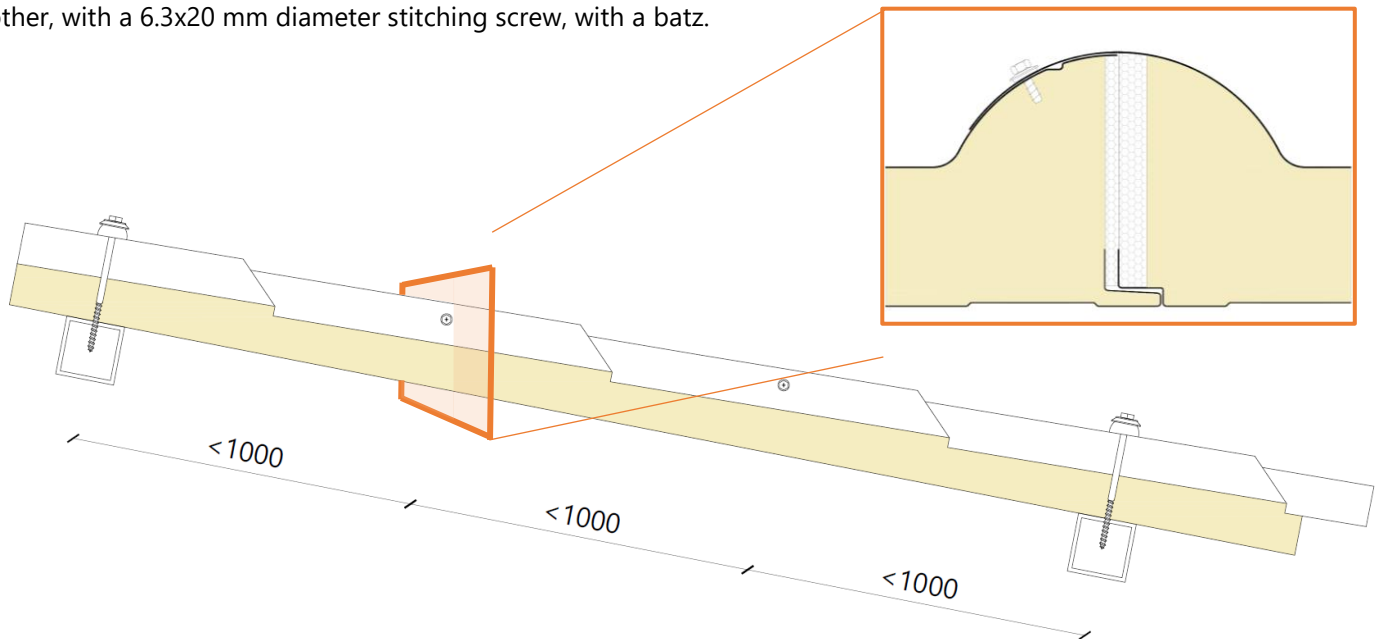

Additional measures to be taken in the event:

Additional measures are provided during the design and construction phase if safety requirements of the roof are increased; a similar case occurs, for example, when the slope is not regular, when strong wind loads are present or with rain and snow accompanied by high wind the same happens when several surfaces and valleys meet at one point of the eaves, when protruding parts on the roof surface impede the flow of water or when working with transverse joints.

The following additional measures may apply, to name some examples:

- increase in the slope of the roof
- additional hermetic sealing measures
- increase in longitudinal covering
- increase in transversal covering.

Examples of solutions for the installation of MB COPPO panels

Connection roof / external gutter

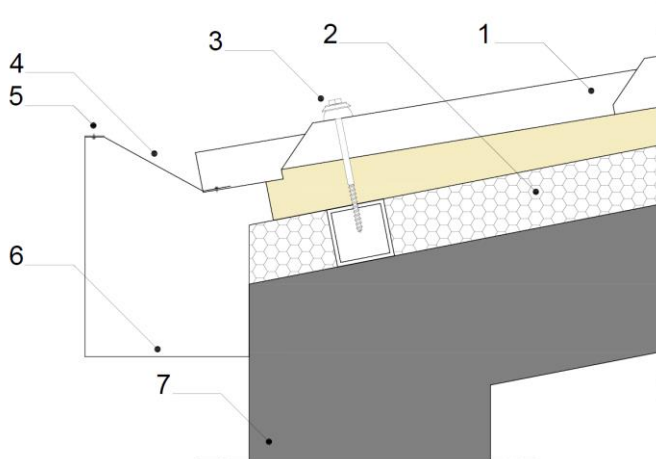

1	MB COPPO panel
2	On site insulation
3	Fixing screw with batz
4	Gutter bracket
5	Rivet
6	Gutter
7	Supporting structure

Connection roof / external gutter with waterproofing sheet

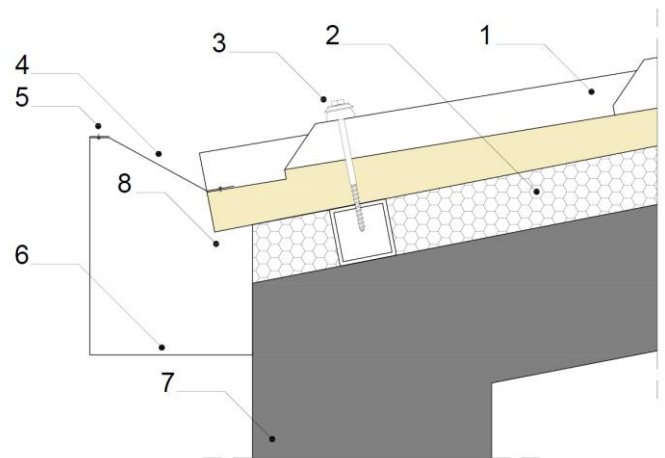

1	MB COPPO panel
2	On site insulation
3	Fixing screw with batz
4	Gutter bracket
5	Rivet
6	Gutter
7	Supporting structure
8	Waterproofing sheet

The solutions represented in this chapter only show some installation variants and they do not have any design value. The designer and the project manager must chose and design the most appropriate solution, case by case.

Connection roof / wall

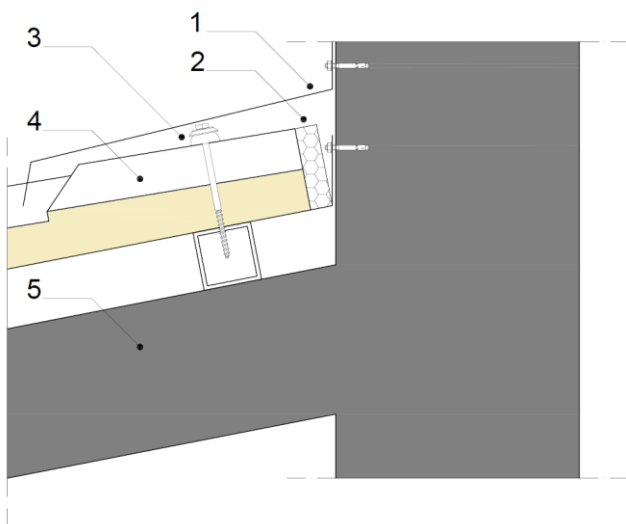

1	Wall flashing with fixing system
2	On site insulation
3	Fixing screw with batz
4	MB COPPO panel
5	Supporting structure

Side connection roof / wall

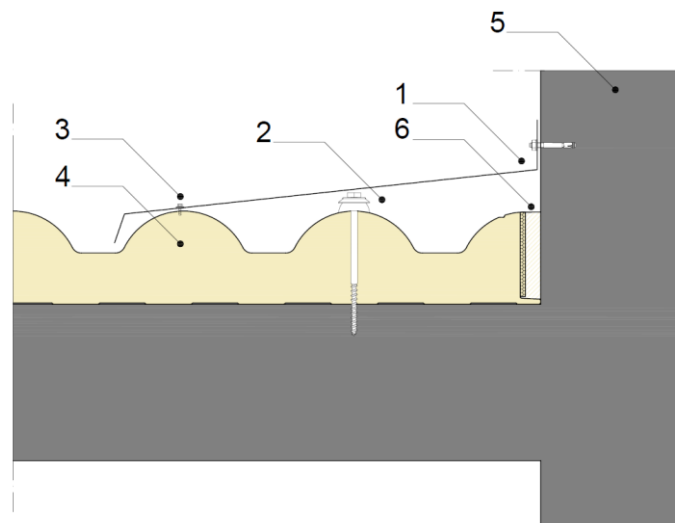

1	Wall flashing with fixing system
2	Fixing screw with batz
3	Flashing / panel fixing screw
4	MB COPPO panel
5	Supporting structure
6	On site insulation

Ending side pitch detail

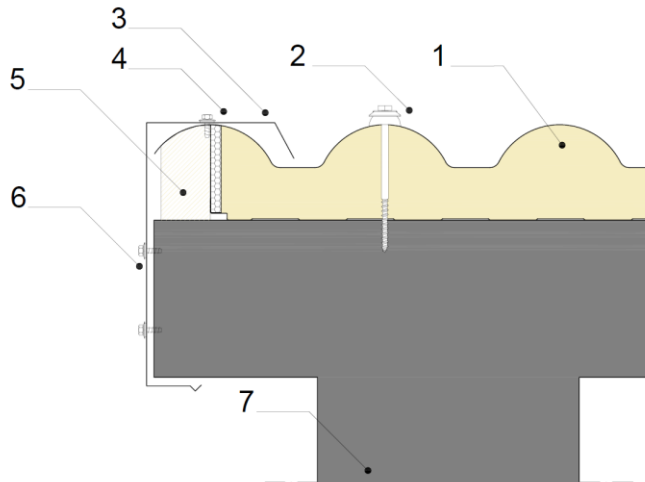

1	MB COPPO panel
2	Fixing screw with batz
3	External tinsmith
4	Tinsmith / panel fixing screw
5	On site insulation
6	Tinsmith / structure fixing screw
7	Supporting structure

Connection roof / internal gutter

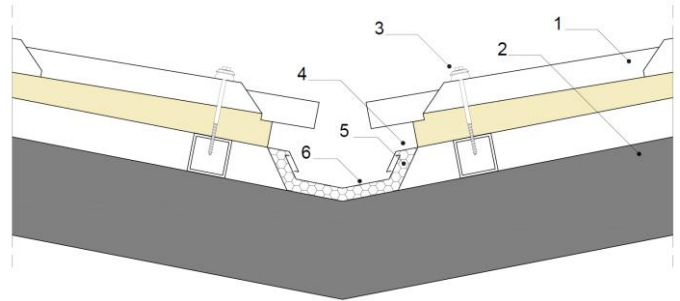

1	MB COPPO panel
2	Supporting structure
3	Fixing screw with batz
4	Drip tray
5	Insulation below the gutter
6	Gutter

The solutions represented in this chapter only show some installation variants and they do not have any design value. The designer and the project manager must chose and design the most appropriate solution, case by case.

Connection roof / flat ridge

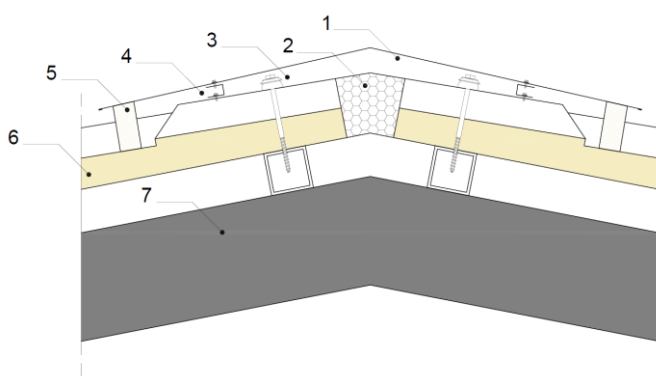

1	Flat ridge
2	On site insulation
3	Fixing screw with batz
4	Supporting element with flashing - ridge fixing
5	Finishing element below the ridge
6	MB COPPO panel
7	Supporting structure

Connection roof / curved ridge

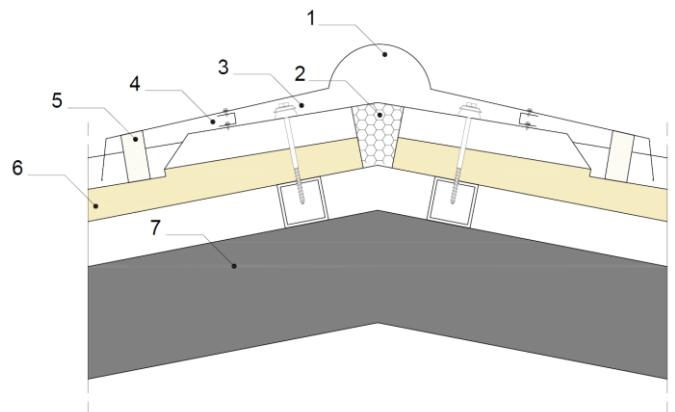

1	Curved ridge
2	On site insulation
3	Fixing screw with batz
4	Supporting element with flashing - ridge fixing
5	Finishing element below the ridge
6	MB COPPO panel
7	Supporting structure

Maintenance and disposal

Roof inspection

During the installation and completion of panels installation, the installing company **will be responsible for the removal of all the material no longer necessary**, including possible scraps of protective film.

The company must pay the utmost attention in eliminating **metal shavings and abrasive elements** in the event that they are deposited on the roof.

During the initial inspection, it is also necessary to check that foreign materials or processing scraps capable of triggering corrosion or damage to the building envelope or that can impede the correct runoff of rainwater have not been left behind.

Periodic inspections should therefore be carried out (recommended every 6 months) to check the conservation status of surfaces.

Routine maintenance

Routine maintenance is the responsibility of the end user and has the function of maintaining unchanged aesthetics and functionality of panels over years, following its construction.

The **periodic maintenance plan** must include the checking:

- of **seals**, the deterioration and wear of which could cause a reduction in air and water tightness;
- of all the **fixings** to verify they are correctly tightened.

The following are the main causes of intervention and measures to be taken:

- **Deposits of aggressive substances present in an industrial atmosphere on the roof:** remove substances with jets of water, if the action of the rains is not sufficient. If normal jets are not sufficient to remove deposited substances, mild and non-abrasive detergents dissolved in water can be used. During the inspection, pay particular attention to products of an aggressive nature coming from **chimneys or ventilation systems**.
- Confluence of materials deposited by the wind or the atmosphere in **gutters** and **valleys**: proceed with a vigorous washing to prevent the metallic support from being damaged or the normal flow of water to be obstructed.

- **Scratches or abrasions of pre-painted parts** caused by the transit of operators or by accidental causes: eliminate by touching up the paint.
- **Loss of elastic or sealing properties of the seal** in joints of the sheet metalwork: restore the seal, after cleaning the pre-existing one.
- **Settling of structures and panels with loosening of fixing screws:** check and carefully tighten screws.
- **Dents caused by impacts:** in some cases it will be possible to intervene by restoring the surface; if this type of intervention is not feasible, the damaged panel must be replaced.
- **Formation of mould and algae**, possible in the case of environments with high humidity, in the shade or with stagnant water: moisten the area to be cleaned with cold water and then, using a non-abrasive brush, remove deposits with a very diluted solution of water, bleach and a cup of liquid soap. Rinse with clean water.
- **Deposits of salt**, for example in marine environments: in the case of light superficial incrustations, it is sufficient to use cold water through a garden hose at the standard pressure of the mains water supply. For all other cases, it is necessary to dampen the surface to be treated with cold water and then, using a non-abrasive brush, remove deposits with a very diluted solution of water, bleach and a cup of liquid soap. Rinse with clean water.

Failure to comply with these warnings, as well as the use of boiling water or abrasive material (brushes with metal bristles, etc.) can cause permanent damage to the surface, compromising the lifespan of product. For further information consult the technical information, "Maintenance and restoration of pre-painted parts".

Disposal

The disposal of insulated roofing panels must only be entrusted to authorized companies and carried out in compliance with the laws in force.

Safety data

Please note that the product to which this document refers is classified in accordance with the regulation (EC) 1907/06-REACH as an article without intentional release of chemical substances and as such does not require the preparation of a safety data sheet.

However, Marcegaglia Buildtech wishes to identify main dangers due to the use of the article in question.

1. Product identification

Insulated panel composed of two metal layers that contain a solid insulating layer of polyurethane foam.

Company / business identification

MARCEGAGLIA Buildtech S.r.l.

Via Giovanni della Casa 12 - 20151 Milano - Italy

Phone +39.0230704.1 fax +39.0233402706

e-mail: tamponamento@marcegaglia.com

2. Dangers identification

The product does not pose dangers to human health under normal conditions of use in accordance with REG EC 1272/08.

3. Composition / information on ingredients

The product is composed of two pre-painted steel sheets containing an insulating layer of polyurethane foam.

Component	% in weight
Metal supports	47-63
Gaskets	≈1
Insulating material	36-52

4. First aid measures

The handling of the product without the appropriate PPE can cause injuries to the skin and eyes due to the presence of steel sheets; in the event of injuries contact a doctor immediately. In case of prolonged exposure to the dust, transport the affected person to a ventilated place.

5. Fire prevention measures

Polyurethane foam is non-flammable, but as an organic material it is combustible. However, the protection of metallic supports allows the risk of fire to be reduced to a low level.

The material used for packaging is combustible and if involved in a fire produces gases and fumes which could reduce visibility.

Extinguishing media

All extinguishing media are applicable. For large fires, use water, alcohol-resistant foams or universal foams according to manufacturer's instructions. For fires of limited proportion, use carbon dioxide or chemical powder.

6. Measures in case of accidental release

The product is stable; no special measures are expected to be taken.

In the event of accidental release of polyurethane dusts (coming, for example, from cutting operations), remove the material preferably with suction systems, ventilate the room and keep away from sources of ignition. Perform these operations with a protective mask.

7. Handling and storage

Handle using the appropriate personal protective equipment. For more information about handling and the personal protective equipment to be used, see section 8. For correct handling and correct storage, refer to the "Regulations for handling and storage of materials" in the technical manual.

8. Personal protection

Respiratory protection

Normal use does not require any protection for the respiratory tract. If it is necessary for work activities to cut panels and carry out any operation that could lead to the generation of dust, it is advisable to install an appropriate extraction and reduction system.

When this is not possible or concentrations of dust in the working environment remain at high concentrations, the possibility of isolating the dust production area or providing operators with devices for the protection of the respiratory tract is evaluated.

Hands protection

The presence of steel sheets can cause cuts or injuries to the skin tissue, and in this regard during normal operations involving the handling of panels, leather or hide gloves resistant to abrasion, cutting, tearing and perforation must be worn in conformity with the UNI EN 388 standard.

Eyes protection

Normal use does not require any protection for the eyes. If it is necessary for work activities to cut panels and carry out any operation that could lead to the production of shards or projectile particles, it is advisable to wear polycarbonate glasses to protect against the projection of

particles at high speed / low impact energy; compliant with standard EN 166.

Skin protection

Normal use does not require any specific protection other than work clothes.

Control of the environmental exposure

Normal use does not require any specific measure to reduce environmental exposure as the product is to be considered non-toxic. Should it be necessary to cut panels and carry out any operation that could lead to the generation of dust, install an extraction system with an appropriate abatement system in order to limit environmental pollution.

9. Physical and chemical properties

Appearance: the product comes in the form of a panel clad in metal and a core of straw-coloured expanded polyurethane foam.

Odour: Odourless

Boiling point: not applicable

Melting point: the sheet melts based on the metal, the polyurethane does not melt or drip.

Flash point: polyurethane between 300 and 400°C.

Calorific value: 6500-7500 kcal / kg

Auto-ignition: not applicable

Explosive properties: not applicable

Oxidizing properties: not applicable

Vapour pressure: not applicable

Water solubility: not applicable

Fat solubility: not applicable

Partition coefficient: not applicable

10. Stability and reactivity

Pre-painted steel and polyurethane are stable under normal weather conditions.

Conditions to avoid:

Avoid using naked flames near polyurethane dust.

11. Toxicological information

With the present state of knowledge, the material is to be considered non-toxic.

12. Ecological information

There are no known harmful effects on the environment.

Should it be necessary to cut panels and carry out any operation that could lead to the generation of dust, install an extraction system with an appropriate abatement system in order to limit environmental pollution.

13. Disposal considerations

The disposal of polyurethane insulated panels must only be entrusted to authorized companies and carried out in compliance with the laws in force.

14. Transport information

No special measures must be taken during transport.

15. Regulatory information

No restrictions pursuant to Annex XVII of the REACH Regulation. No ingredient is included in the REACH Candidate List (> 0.1 % m/m). Regulation (EC) No. 1907/2006 of the European Parliament and of the Council, of December 18, 2006, concerning the registration, evaluation, authorization and restriction of chemical substances (REACH).

Regulation (EC) No. 1272/2008 of the European Parliament and of the Council of December 16, 2008 concerning the classification, labelling and packaging of substances and mixtures which amends and repeals Directives 67/548/EEC and 1999/45/EC and amends regulation (EC) No. 1907/2006.

Regulation 830/2015 Annex II of REACH.

Legislative decree 81/2008 Consolidated Law on Occupational Health and Safety.

16. Other information

The information contained in this sheet are based on our knowledge and experience at the date of the latest version. The user must verify the suitability and completeness of the information in relation to the specific use of the product.

This document must not be interpreted as a guarantee of any specific property of the product. Since the use of the product does not fall under our direct control, it is the user's obligation under its responsibility to observe the laws and regulations in force concerning hygiene and safety.

No liability is assumed for improper use. Provide adequate training for the personnel involved in the use of chemical products.



Registered seat:

via Bresciani 16 • 46040 Gazoldo degli Ippoliti (MN) - Italy
phone + 39 . 0376 6851
tamponamento@marcegaglia.com
www.marcegagliabuildtech.it

Main offices and plant:

MARCEGAGLIA Pozzolo Formigaro
Strada Roveri 4 • 15068 Pozzolo Formigaro (AL)- Italy
phone + 39 0143 7761
pozzolo@marcegaglia.com